

УДК 62-752 (045)

T. Nahdi, Postgraduate, Czech Technical University in Prague

D. Maga, PhD, Professor, Czech Technical University in Prague

Yu. V. Turygin, DSc, Professor, Kalashnikov Izhevsk State Technical University

ANALYSIS AND SIMULATION OF ENERGY HARVESTING SYSTEM FROM MECHANICAL VIBRATIONS

Energy harvesting is the conversion of ambient energy present in the environment into electrical energy. It is identical in principle to large-scale renewable energy generation, for example, solar or wind power, but very different in scale. While large-scale power generation is concerned with megawatts of power, energy harvesting typically refers to micro- to milli-watts [1, 2], i.e. much smaller power generation systems [3].

The development of energy harvesting system has been driven by the proliferation of autonomous wireless electronic systems [4]. A classic example of such systems are wireless sensor nodes which combine together to form wireless sensor networks. Each sensor node typically comprises a sensor, processing electronics, wireless communications, and power supply [5]. Since the system is by definition wireless and cannot be plugged into a mains supply, power has to be provided locally. Typically such a local power supply is provided a battery which on the face of it is convenient and low cost. However, batteries contain a finite supply of energy and require periodic replacement or recharging. This may be fine in individual deployments but across a wireless network containing a multitude of nodes batteries are clearly not attractive. Furthermore, the need to replace batteries means the wireless system has to be accessible which may not be possible or may compromise performance [1–5, 11, 14].

By converting ambient energy in the environment, the energy harvester can provide the required electrical power for the lifetime of the wireless system which is also free to be embedded or placed wherever it is best suited to perform its function. Energy harvesting typically exploit kinetic, thermal, solar sources, or electromagnetic radiation sources (fig. 1).

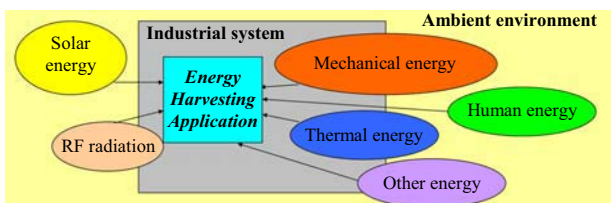

Figure 1. Available energy from the ambient environment

Mechanical energy can be found almost anywhere that wireless sensor networks (WSN) may potentially be deployed, which makes converting mechanical energy from ambient vibration into electrical energy an attractive approach for powering wireless sensors. The source of mechanical energy can be a moving human body or

a vibrating structure. The frequency of the mechanical excitation depends on the source: less than 10 Hz for human movements and over 30 Hz for machinery vibrations [2]. Such devices are known as kinetic energy harvesters or vibration power generators [6, 7]. In practical machine-based applications, vibration levels can be very low ($<1 \text{ m s}^{-2}$) at frequencies that often correspond to the frequency of the mains electricity powering the plant (e.g. 50 or 60 Hz or harmonics). Such low levels of vibration equate to amplitudes of vibration that are in the order of a few microns and the only way to extract mechanical energy in this case is to use an inertial generator that resonates at a characteristic frequency.

The principle behind the vibration energy harvesting is a resonance operation of an oscillating mass and consequent an electro-mechanical conversion of mechanical energy into electrical energy [6–8, 10]. The fundamental part of the vibration energy harvester is a resonance mechanism. An oscillation inside the resonance mechanism can be converted by any physical principle of the electromechanical conversion. The vibration energy harvesters use usually principles of a piezo-electric, magnetostriction, electro-static or electro-magnetic mechanical conversion [1, 5, 10].

The choice of suitable energy harvesting devices design and physical method of energy conversion are very important for efficient harvesting of energy (fig. 2). As mentioned before the efficiency of energy harvesting is in nature very low. The obtained energy can be used to recharge a secondary battery (supercapacitors) or, in our case, to power directly electronics or sensors for telecommunication appliances for example [1, 3–5]. The output voltage and current of the generators is transient and discontinuous in nature, and usually it must be converted to a DC signal.

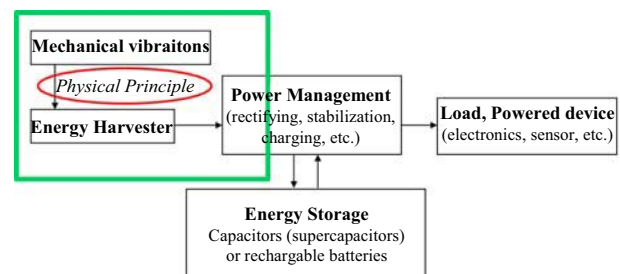

Figure 2. Schematic diagram of energy harvesting system

In this paper we are studying the branch of energy harvesting from mechanical vibrations [6–12]. The common vibration energy harvesting application consists

of precise mechanical resonance mechanism, electro-mechanical converter (piezoelectric, electromagnetic, electrostatic and magnetostrictive), power electronics and a powered autonomous application (fig.2). This complex system can be perceived as a mechatronic system and the mechatronic approach can be used for the development of new vibration energy harvesting applications [2].

Energy harvesting system from mechanical vibrations

A. Generic model of energy harvesting system excited by mechanical vibrations

Inertial-based of vibration energy harvesters are modelled as second-order, spring-mass systems. The generic model of vibration energy harvesters was first developed by Williams and Yates [15]. Figure 3 shows a generic model of such a generator, which consists of a seismic mass, m , and a spring with the spring constant of k . When the generator vibrates, the mass moves out of phase with the generator housing.

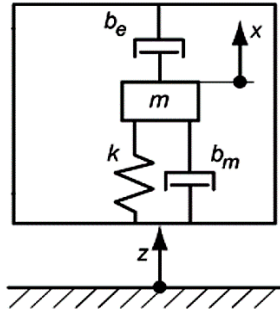

Figure 3. General model of resonant mechanism excited by mechanical vibration

There is a relative movement between the mass and the housing. This displacement is sinusoidal in amplitude and can drive a suitable transducer to generate electrical energy. b is the damping coefficient that consists of mechanically induced damping (parasitic damping) coefficient b_m and electrically induced damping coefficient b_e , i.e. $b = b_m + b_e$. $z(t)$ is the displacement of the generator housing and $q(t)$ is the relative motion of the mass with respect to the housing. For a sinusoidal excitation, $z(t)$ can be written as $z(t) = Z \sin \omega t$, where Z is the amplitude of vibration and ω is the angular frequency of vibration.

A1. Transfer Function

The above resonant mechanism is described by the following equation of motion:

$$m\ddot{x} + b\dot{x} + kx = -m\ddot{z}, \quad (1)$$

where:

m : resonant mass (kg)

$b = b_m + b_e$: the damping coefficient [$N \cdot m^{-1} \cdot s$]

k : stiffness of mechanism [$N \cdot m^{-1}$]

x, \dot{x}, \ddot{x} : relative coordinates of position, velocity and acceleration [$m, m \cdot s^{-1}, m \cdot s^{-2}$]

\ddot{z} : acceleration of vibrations [$m \cdot s^{-2}$]

Equation (1) can be written in the form after the Laplace transform as:

$$m \cdot s^2 \cdot z(s) + b \cdot s \cdot z(s) + k \cdot z(s) = -m \cdot a(s), \quad (2)$$

where $a(s)$ is the Laplace expression of the acceleration of the vibration, $a(t)$, which is given by:

$$a(t) = \frac{d^2 y(t)}{dt^2}. \quad (3)$$

Thus, the transfer function of a vibration-based micro-generator is:

$$\frac{z(s)}{a(s)} = \frac{1}{s^2 + \frac{b}{m}s + \frac{k}{m}} = \frac{1}{s^2 + \frac{\omega_r}{Q}s + \omega_r^2}, \quad (4)$$

where $Q = \sqrt{km} / b$ is the quality factor and $\omega_r = \sqrt{k/m}$ is the resonant frequency.

A2. Equivalent circuit

An equivalent electrical circuit for a kinetic energy harvester can be found from Eq. (4), which, when rearranged, gives:

$$-m \cdot a(s) = s \cdot Z(s) \cdot \left(ms + b + \frac{k}{s} \right). \quad (5)$$

Equation (5) can be written as:

$$-m \cdot a(s) = s \cdot Z(s) \cdot \left(ms + b + \frac{k}{s} \right), \quad (6)$$

where

$$I(s) = m \cdot a(s), E(s) = s \cdot Z(s), C = m, R = \frac{1}{b}, L = \frac{1}{k}.$$

Based on Eq.(6), an equivalent electrical circuit can be built as shown on fig. 4.

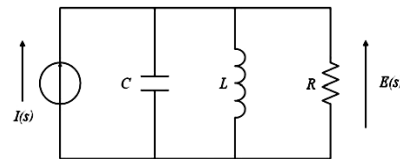

Figure 4. Equivalent circuit of a vibration energy harvester

Damping in vibration energy harvesters consists of mechanically induced damping and electrically induced damping. The overall damping factor of the system, ξ_T is given by:

$$\xi_T = \frac{b}{2m\omega_r} = \frac{b_m + b_e}{2m\omega_r} = \xi_m + \xi_e, \quad (7)$$

where $\xi_m = b_m / 2m\omega_r$ is the mechanically induced damping factor and $\xi_e = b_e / 2m\omega_r$ is the electrically induced damping factor.

Total quality factor (Q -factor) is a function of damping factor. The total Q -factor is given by:

$$Q_T = \frac{1}{2\xi_T}. \quad (8)$$

This is the Q -factor when the generator is connected to the optimum load. The relation between total quality factor and the electrical and mechanical damping is given by:

$$\frac{1}{Q_T} = \frac{1}{Q_{OC}} + \frac{1}{Q_e}, \quad (9)$$

where $Q_{OC} = 1/2\xi_m$ is the open circuit Q -factor which reflects the mechanical damping. $Q_{OC} = 1/2\xi_e$ reflects performance of the transduction mechanism. It cannot be measured directly, but can be calculated using Eq. (9) once Q_T and Q_{OC} are measured.

A3. Output Power of a vibration Energy Harvesters

Assume that the input is a sinusoid excitation, i.e. $z(t) = \sin \omega t$. The solution to Eq. (1) is given by:

$$z(t) = \frac{m \cdot \omega^2 \cdot Z}{k - m\omega^2 + j\omega b} \cdot \sin \omega t \quad (10)$$

or

$$z(t) = \frac{\omega^2}{\sqrt{(\omega_r^2 - \omega^2)^2 + \left(\frac{b\omega}{m}\right)^2}} \cdot Z \sin(\omega t + \varphi), \quad (11)$$

where φ is the phase angle given by:

$$\varphi = \tan^{-1} \left(\frac{b\omega}{k - \omega^2 m} \right). \quad (12)$$

The average power dissipated within the damper, i.e. the sum of the power extracted by the transduction mechanism and the power lost in mechanical damping is given by:

$$P = b \left(\frac{dz(t)}{dt} \right)^2. \quad (13)$$

Equations (11) and (13) give the average power dissipated within the damper as follows:

$$P(\omega) = \frac{m\xi_T Z^2 \left(\frac{\omega}{\omega_r} \right)^3 \omega^3}{\left[1 - \left(\frac{\omega}{\omega_r} \right)^2 \right]^2 + \left(2\xi_T \frac{\omega}{\omega_r} \right)^2}. \quad (14)$$

When the generator is at resonance, i.e. $\omega = \omega_r$, the power dissipation reaches maximum. The maximum dissipated power is:

$$P = \frac{mZ^2 \omega_r^3}{4\xi_T} \quad (15)$$

or

$$P = \frac{mZ^2 \omega_r^3}{4(\xi_m + \xi_e)}. \quad (16)$$

The power dissipation is the sum of maximum electrical energy extracted by the transduction mechanism, P_e , and mechanical loss, P_m . P_e and P_m are as follows:

$$P_e = \frac{\xi_e mZ^2 \omega_r^3}{4(\xi_m + \xi_e)}; \quad (17)$$

$$P_m = \frac{\xi_m mZ^2 \omega_r^3}{4(\xi_m + \xi_e)}. \quad (18)$$

Maximum power conversion from mechanical domain to electrical domain occurs when $\xi_e = \xi_m$, i.e. damping arising from the electrical domain equals mechanical losses.

$$b_e = b_m. \quad (19)$$

Therefore, the maximum electrical power that can be extracted by the kinetic energy harvester, P_e , is given by:

$$P_e = \frac{P}{2} = \frac{mZ^2 \omega_r^3}{16\xi_m}. \quad (20)$$

Since the peak acceleration of the base, a , is given by $a = Z\omega^2$, Eq. (20) can be rewritten as:

$$P_e = \frac{ma^2}{16\omega_r \xi_m}. \quad (21)$$

As the open circuit Q -factor, $Q_{OC} = 1/2\xi_m$, Eq. (21) can be written as:

$$P_e = \frac{ma^2}{8\omega_r} \cdot Q_{OC}. \quad (22)$$

It is found via Eq. (22) that the maximum power delivered to the electrical domain is inversely proportional to the damping factor, i.e. proportional to the Q -factor. Hence, when designing a vibration energy harvester to achieve maximum power output, it is important to design the vibration energy harvester with a high Q -factor (i.e. low damping factor) and make it work at its resonant frequency.

B. Simulation of an energy harvesting system excited by mechanical vibrations

The aim of the modelling of the energy harvesting system is to determine the output power of dissipative forces on electric damper b_e , which works in the maximum theoretical mode while maintaining the condition (19). During simulation, the model is excited by measured vibrations (vibrations of an horizontal milling machine tools) and theoretical output power is calculated based on the linear model of the entire energy harvesting system. This output power is further integrated and the value of the energy obtained in time for the respective operating frequency of the resonant mechanism is also shown. The entire simulation model was created in Simulink and is shown in Figure 5.

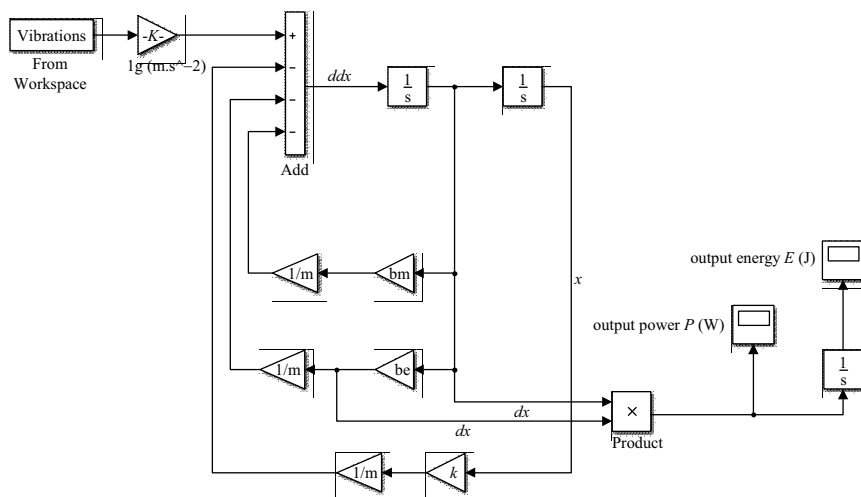

Figure 5. Model of an energy harvesting system excited by measured vibrations

The calculation of the theoretically obtainable amount of electricity requires the determination of the parameters of the model of energy harvesting generator. This is essentially the mass of resonant member (m) and the quality of the entire resonant mechanism (Q). We choose to analyze the vibration mass of 100 grams and the quality factor of 80.

Energy analysis

A. Measured vibrations

The analysis of the machine tool vibrations was executed on the Brno Technical University (VTU) [1]. The measurements are performed on a demonstrator which is a horizontal milling machine tool. The vibration measurements were measured during climb and conventional milling. The vibration and the Fast Fourier transform (FFT) are presented in Figure 6 and 7.

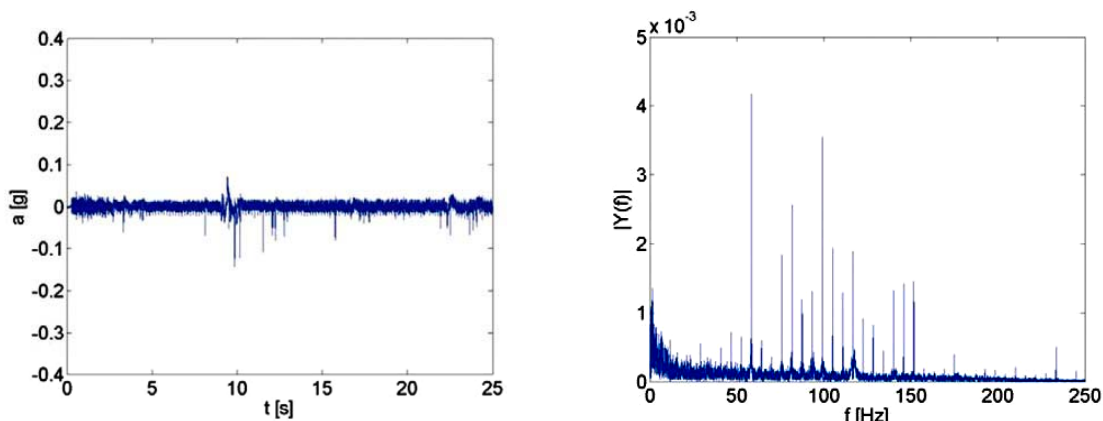

Figure 6. Measured vibrations and FFT analysis during climb milling

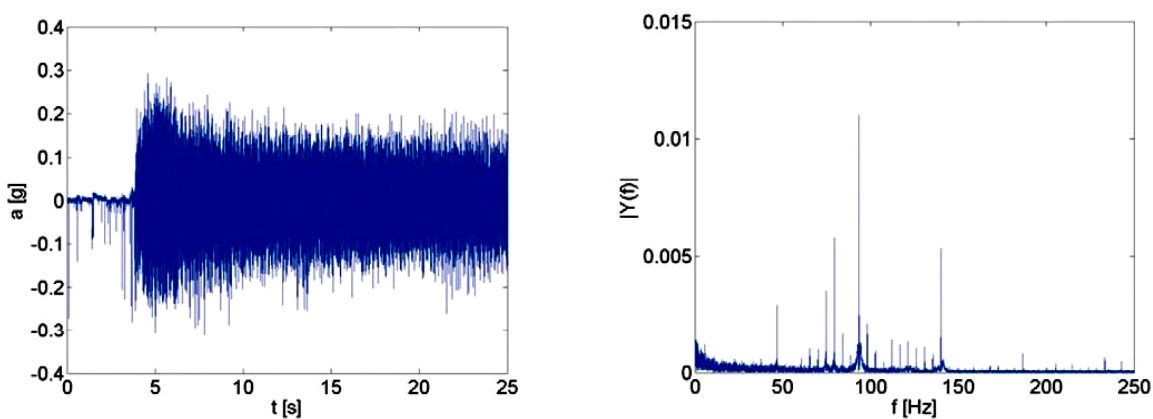

Figure 7. Measured vibrations and FFT analysis during conventional milling

Figure 6 and 7 illustrates the waveform of vibrations and their spectrum for climb and conventional milling. It can be seen that the conventional milling transfers to the horizontal milling machine tool a quantitatively greater vibration output power, and we also assume even the achievement of greater obtained electrical output power. In addition to the dominant frequency given by revolutions and number of tool teeth, there are also other frequencies that are similar for both climb and conventional milling.

B. Analysis of the output power and the total electric power

The results of the energy analysis performed in Simulink (Fig. 5.) are shown in details in Fig. 8 and 9.

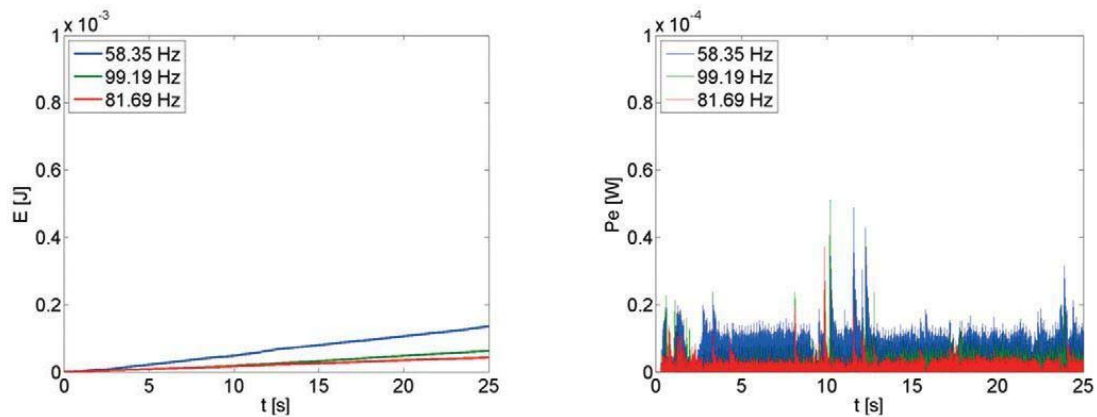

Figure 8. Calculated instantaneous output power and total electrical power generation for selected dominant frequencies – Climb milling

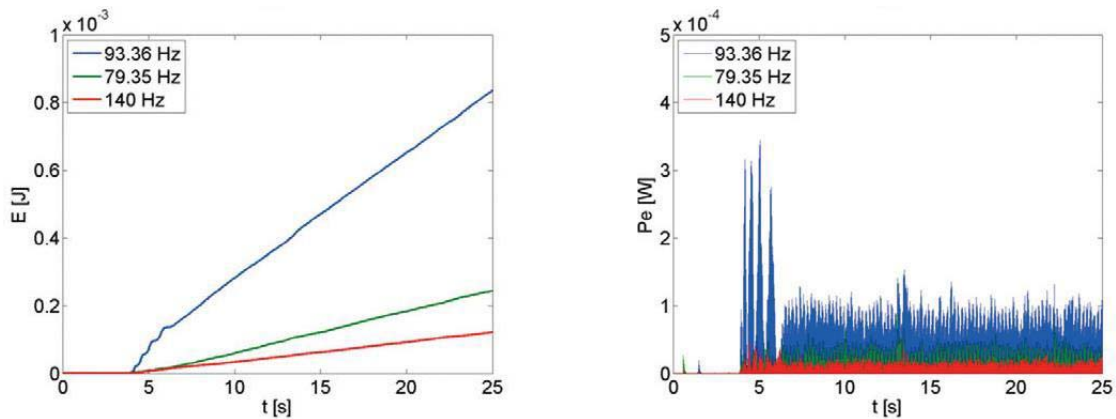

Figure 9. Calculated instantaneous output power and total electrical power generation for selected dominant frequencies – Conventional milling

Besides the parameters of resonant circuit that converts vibrations into electrical energy, it is also important to choose suitable electronics, the so-called power management. This electrical circuit ensures an optimal operating point of the generator according to equation (19) and during several hours by generating very little output power it can gain sufficient power for wireless sensors [13]. The market currently offers several tens of circuit types for various generators and energy consumption, which are primarily used by supercapacitors and Thin Film Battery for electric energy accumulation.

There is a visible difference in the obtained energy from ambient vibrations using a model of vibration energy harvester for climb and conventional milling.

The output power of 100–200 μ Watt set by modeling can currently be used to power MEMS sensors in the so-called Burst mode where energy is obtained over a longer period of time, and then used for measuring and sending the data to the diagnostic or control unit. The output power required for such a device depends on the respective wireless technology and broadcast frequency of such application [14]. Also significant is the problem of shielding the radio signal which increases energy demands.

Conclusion

The above analysis was carried out theoretically from a linear model of an energy harvesting system excited by measured vibrations and the physical principle of electromechanical conversion was not solved. For the analyzed frequencies and output power, it seems more appropriate to make the analysis of other types of vibration energy harvesting systems.

As mentioned in this paper, there are three methods typically used to convert mechanical vibration to an electrical signal. They are: electromagnetic (inductive), electrostatic (capacitive), and piezoelectric. These three

methods are all commonly used for wireless sensors. Conversion of energy intended as a power source rather than a sensor signal will use the same methods, however, the design criteria are significantly different, and therefore the suitability of each method should be evaluated in terms of its potential for energy conversion on the meso and micro scale.

Acknowledgment

This work has been supported by an Institutional support for development and research.

References

1. Nahdi T., Maga D. Brief Survey on Energy Harvesting in Telecommunication Technologies // RTT 2014. – Praha : CVUT, 2014. – Pp. 19–23. – ISBN 978-80-01-05540-3 (ISBN 978-80-01-05539-7).
2. Development of energy harvesting sources for remote applications as mechatronic systems / Z. Hadas [et al.] // 14 Th International Power Electronics and Motion Control Conference (EPE/PEMC), 2010. – Pp. T10–13–T10–19.
3. Mateu L., Moll F. Review of Energy Harvesting Techniques and Applications for Microelectronics // SPIE Micrtechnologies for the New Millennium. – Jun. 2005. – Pp. 359–373.
4. Park C., Chou P. H. AmbiMax: Autonomous energy harvesting platform for multi-supply wireless sensor nodes // Proceedings of the 3rd Annual IEEE Communications Society on Sensor and Ad Hoc Communications and Networks (SECON). – Sep. 2006. – Vol. 1. – Pp. 168–177.
5. Paradiso J. A., Starner T. Energy scavenging for mobile and wireless electronics // IEEE Pervasive Computing. – Jan. 2005. – Vol. 4. – No. 1. – Pp. 18–27.
6. Hadas Z., Huzlik R. FEM Model of Electro-magnetic Vibration Energy Harvester // Mechatronics 2013 Recent Technological and Scientific Advances. – Springer, 2013. – s. 371–377. – ISBN: 978-3-319-02293-2.
7. Model- based design and test of vibration energy harvester for aircraft application / Z. Hadas, V. Vetiska, R. Huzlik, V. Singule // Microsystem Technologies. – 2014. – roč. 20. – č. 4-5. – S. 841-843. – ISSN: 0946-7076.
8. Buren T. von, Troster G. Design and optimization of a linear vibration-driven electromagnetic micro-power generator // Sensors and Actuators A: Physical. – Apr. 2007. – Vol. 135. – No. 2. – Pp. 765–775.
9. Thermoelectric converters of human warmth for self-powered wireless sensor nodes / V. Leonov, T. Torfs, P. Fiorini, C. V. Hoof // IEEE Sensors Journal. – May 2007. – Vol. 7. – No. 5. – Pp. 650–657.
10. Vibration-to-electric energy conversion / S. Meninger, J. O. MurMiranda, R. Amirtharajah, A. P. Chandrakasan, J. H. Lang // IEEE Transactions on Very Large Scale Integration (VLSI) Systems. – Feb. 2001. – Vol. 9. – No. 1. – Pp. 64–76.
11. Amirtharajah R., Chandrakasan A. P. Self-powered signal processing using vibration-based power generation // IEEE Journal of Solid-State Circuits. – May 1998. – Vol. 33. – No. 5. – Pp. 687–695.
12. Architectures for vibration-driven micropower generators / P. D. Mitcheson, T. C. Green, E. M. Yeatman, A. S. Holmes // Journal of Microelectromechanical Systems. – Jun. 2004. – Vol. 13. – No. 3. – Pp. 429–440.
13. Circuits for energy harvesting sensor signal processing / R. Amirtharajah [et al.] // 43 rd Design Automation Conference, Proceedings. – 2006. – Pp. 639–644. – Available at: <Go to ISI>://WOS:000240104100126.
14. Design considerations for ultra-low energy wireless microsensor nodes / B. H. Calhoun [et al.] // Ieee Transactions on Computers. – 2005. – 54. – Pp. 727–740. – Available at: <Go to ISI>://000228-362100009.
15. Williams C. B., Yates R. B. Analysis of a micro-electric generator for Microsystems // Sens. Actuators, A. – 1996. – Vol. 52. – Pp. 8–11.

Получено 11.02.2015

УДК 658.512.4.011.56

С. Д. Кугультинов, доктор технических наук, профессор, ИжГТУ имени М. Т. Калашникова
В. А. Красильникова, студентка, ИжГТУ имени М. Т. Калашникова

РАЗРАБОТКА КЛАССИФИКАТОРА ИНСТРУМЕНТАЛЬНОЙ ОСНАСТКИ КАК ОСНОВЫ ДЛЯ СОЗДАНИЯ СИСТЕМЫ УКРУПНЕННОГО АВТОМАТИЗИРОВАННОГО ПРОЕКТИРОВАНИЯ И НОРМИРОВАНИЯ ТЕХНОЛОГИЧЕСКИХ ПРОЦЕССОВ

Автоматизация проектирования и технологической подготовки производства может обеспечить жизнеспособность предприятия и дать ему возможность развиваться в нынешних условиях чрезвычайно жесткой рыночной конкуренции. И напротив, если предприятие не разрабатывает и не реализует автоматизированные системы, то оно будет неспособно выдерживать конкуренцию по потребительской стоимости, качеству и расходам.

Одним из наиболее эффективных путей разработки системы автоматизированного проектирования

и нормирования технологических процессов (САПР и НТП) является закладывание в нее унифицированных, типизированных и стандартизованных решений. Здесь в роли генератора решений выступает система автоматизированного проектирования, а специалист – пользователь данной системы – выступает в качестве эксперта выдвигаемых решений или процедур [1]. В перспективе стоит использовать общезаводскую конструкторско-технологическую программную среду для ускорения процессов конструирования машин, разработки техноло-